



Tango G3 - BVP38x

BVP383 LED365/WW 360W 220-240V AMB

The energy-saving Philips Tango G3 LED Floodlight is the ideal solution for a wide range of Area lighting applications. It incorporates the LED light source, optical system, heat sink and driver into one compact and robust housing that meets globally recognised safety standards. Its specially designed heat sink incorporates aesthetics and functionality to ensure excellent reliability. Powered by LED technology, this luminaire delivers superior performance and a longer lifetime, bringing area lighting to a whole new level.

Product data

General Information	
Lamp colour code	Warm white
Light source replaceable	Yes
Driver/power unit/transformer	PSU [Power supply unit]
Driver included	Yes
Optical cover/lens type	PC-MLO [Polycarbonate micro lens optic]
Luminaire light beam spread	35° x 100°
Control interface	-
Connection	Flying leads/wires
Cable	Cable 0.5 m without plug
Protection class IEC	Safety class I (I)
CE mark	-
Warranty period	3 years
Optic type outdoor	Asymmetrical medium beam
Light source engine type	LED
Operating and Electrical	
Input Voltage	220-240 V
Input frequency	50 or 60 Hz

Power factor (min.)	0.95
Controls and Dimming	
Dimmable	No
Mechanical and Housing	
Housing material	Aluminum die-cast
Optic material	Polycarbonate
Optical cover/lens material	Polycarbonate
Fixation material	Steel
Mounting device	MBA [Mounting bracket adjustable]
Optical cover/lens finish	Frosted
Overall length	591 mm
Overall width	114 mm
Overall height	603 mm
Effective projected area	0.29 m ²
Colour	Aluminium and Grey

Approval and Application	
Ingress protection code	IP66 [Dust penetration-protected, jet-proof]

Tango G3 - BVP38x

Mech. impact protection code	IK08 [5 J vandal-protected]
Surge protection (common/differential)	Surge protection level until 10 kV

Initial Performance (IEC Compliant)

Initial luminous flux	36500 lm
Luminous flux tolerance	+/-10%
Initial LED luminaire efficacy	100 lm/W
Lamp colour temperature	3000 K
Colour Rendering Index	70
Initial chromaticity	SDCM<=7
Initial input power	360 W
Power consumption tolerance	+/-10%

Application Conditions

Ambient temperature range	-40 to +50 °C
---------------------------	---------------

Product Data

Full product code	911401685203
Order product name	BVP383 LED365/WW 360W 220-240V AMB
Order code	911401685203
SAP numerator – quantity per pack	1
Numerator – packs per outer box	1
Material no. (12 NC)	911401685203
Net Weight (Piece)	12.499 kg



Dimensional drawing

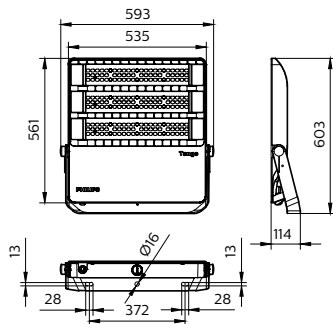

BVP38x Tango G3

