

An energy-efficient solution

EB-Certalume for TL-D lamps

Affordable, reliable, high-frequency electronic ballast for TL-D fluorescent lamps, ideal alternative to electromagnetic fluorescent systems. The cost-saving and reliable EB-C has energy efficiency class A2, and its robust design meets all necessary international standards for safety and EMC. The ballast is primarily designed for indoor use. For outdoor use, the luminaire should be minimum Class II and be sufficiently protected against water and dust. The installation should also be protected against lightning surges or any other electrical protection deemed necessary in this type of installation and application.

Benefits

- Energy-saving solution (CELMA A2)
- Long lifetime of 45,000 hours @ Ta=50 °C
- Conforming to international standards for safety and EMC

Features

- Energy-efficient CELMA A2, high power factor 0.97 with THD < 18%
- Safety according to IEC 61347-2-3, and EMC-compliant with EN 55015 2006 + A1 2007
- Robust design for 45,000 hours lifetime at Ta 50 °C and avg. 6,000 on/off switches on one lamp
- Quick warm, flicker-free lamp start (< 1.0 s), no ignitor needed
- Wide voltage range for ignition and operation (165-253 V)

Application

- Ideal for applications with long burning hours and infrequent on/off switching activity
- Professional indoor applications (e.g. offices and hotels), department stores, shops, supermarkets and public areas and indoor lighting boxes and homes

EB-Certalume for TL-D lamps

Versions



Dimensional drawing

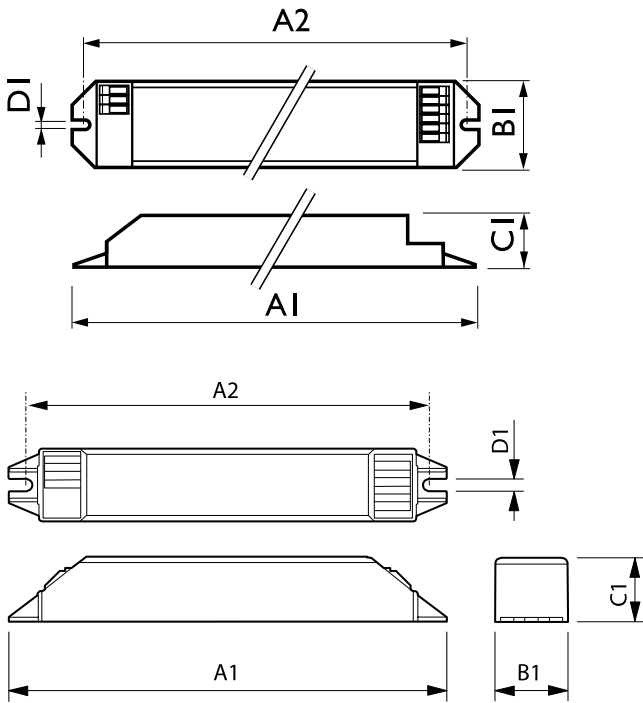

Product	D1	C1	A1	A2	B1
EB-C 236 TL-D 220-240V 50/60Hz	4.2 mm	30.0 mm	210.0 mm	200.0 mm	40.0 mm
EB-C 136 TL-D 220-240V 50/60Hz	4.2 mm	28.0 mm	150.0 mm	140.0 mm	40.0 mm

Product	A1	A2	B1	C1	D1
EB-Ci 1-2 36W / 1-4 18W 220-240V 50/60Hz	210 mm	200 mm	30 mm	26 mm	4.3 mm

Approval and Application

Energy Efficiency Index A2

General Information

Lamp Type TL-D

Operating and Electrical

Order Code	Full Product Name	Input Frequency	Input Voltage
913713043180	EB-Ci 1-2 36W / 1-4 18W 220-240V 50/60Hz	50 or 60 Hz	220-240 V

Order Code	Full Product Name	Input Frequency	Input Voltage
913713199215	EB-C 136 TL-D 220-240V 50/60Hz	50 to 60 Hz	220 to 240 V
913713199315	EB-C 236 TL-D 220-240V 50/60Hz	50 to 60 Hz	220 to 240 V

General Information

EB-Certalume for TL-D lamps

Order Code	Full Product Name	Number Of	Number Of	Number Of
		Products On	Products On	
		MCB (16A	MCB (16A	Lamps
		Type B) (Max)	Type B) (Nom)	
913713043180	EB-Ci 1-2 36W / 1-4 18W 220-240V 50/60Hz	28	-	1-4 piece/unit
913713199215	EB-C 136 TL-D 220-240V 50/60Hz	-	18	1 piece/unit

Order Code	Full Product Name	Number Of	Number Of	Number Of
		Products On	Products On	
		MCB (16A	MCB (16A	Lamps
		Type B) (Max)	Type B) (Nom)	
913713199315	EB-C 236 TL-D 220-240V 50/60Hz	-	28	2 piece/unit

Mechanical and Housing

Order Code	Full Product Name	Housing
913713043180	EB-Ci 1-2 36W / 1-4 18W 220-240V 50/60Hz	L210x30x26mm
913713199215	EB-C 136 TL-D 220-240V 50/60Hz	L 150x40x28

Order Code	Full Product Name	Housing
913713199315	EB-C 236 TL-D 220-240V 50/60Hz	L 210x40x30

System characteristics

Order Code	Full Product Name	Lamp Power On	Rated Ballast-
		TL-D	Lamp Power
913713043180	EB-Ci 1-2 36W / 1-4 18W 220-240V 50/60Hz	18.0-31.0 W	-
913713199215	EB-C 136 TL-D 220-240V 50/60Hz	32.6 W	36 W

Order Code	Full Product Name	Lamp Power On	Rated Ballast-
		TL-D	Lamp Power
913713199315	EB-C 236 TL-D 220-240V 50/60Hz	61.6 W	36 W

