



MASTER LEDspot ExpertColor LV

MASTER LED MR16 ExpertColor 6.7-50W 930 36D

MASTER LEDspot LV ExpertColor creates a warm and comfortable ambience for hospitality venues, homes and restaurants. It creates such an ambience with superior lighting that has a customised spectrum, high CRI and deep dimming feature. The result? A beautiful lighting experience. What's more, the innovative, trimless lens design will suit almost any interior decor with its clean and neat look. In addition, you can take advantage of the full ExpertColor family, which also includes LEDspot MV and LEDspot Par lamps.

Product data

General Information		Operating and Electrical	
Cap base	GU5.3 [GU5.3]	Input frequency	- Hz
EU RoHS compliant	Yes	Power (Rated) (Nom)	6.7 W
Nominal lifetime (nom.)	40000 h	Lamp current (nom.)	650 mA
Switching cycle	50,000X	Wattage equivalent	50 W
		Starting time (nom.)	0.5 s
		Warm-up time to 60% light (nom.)	0.5 s
		Power factor (nom.)	0.7
		Voltage (Nom)	ac electronic 12 V
Light Technical		Temperature	
Colour Code	930 [CCT of 3,000 K]	T-Case maximum (nom.)	92 °C
Technical Beam Angle (Nom)	36 °		
Lamp Luminous Flux 25°C EL (Nom)	480 lm	Controls and Dimming	
Luminous intensity (nom.)	1450 cd	Dimmable	Only with specific dimmers
Colour Designation	White (WH)		
Colour Temperature, horizontal (Nom)	3000 K		
Lamp Luminous Efficacy EM (Nom)	71.00 lm/W		
Colour consistency	<3		
Colour Rendering Index,horiz (Nom)	97		
LLMF at end of nominal lifetime (nom.)	70 %		

MASTER LEDspot ExpertColor LV

Mechanical and Housing

Bulb shape MR16 [2inch/50mm]

Approval and Application

Suitable for accent lighting Yes

Product Data

Full product code 871951435719800
 Order product name MASTER LED MR16 ExpertColor 6.7-50W 930 36D

EAN/UPC – product 8719514357198

Order code 929003077408

SAP numerator – quantity per pack 1

Numerator – packs per outer box 10

SAP material 929003077408

SAP net weight (piece) 0.052 kg

Dimensional drawing

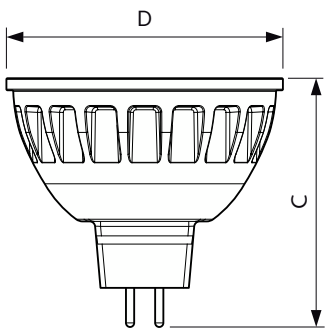

MASTER LED MR16 ExpertColor 6.7-50W 930 36D

Product	D	C
MASTER LED MR16 ExpertColor 6.7-50W 930 36D	50.5 mm	46 mm

Photometric data

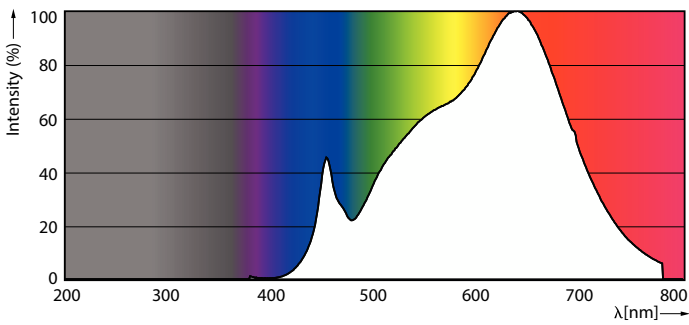

LEDspots MAS IC 6,7W MR16 GU5,3 930 60D-POC

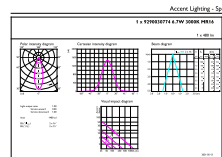

LEDspots GMGC 1 6,7W MR16 GU5,3 930 36D-ADL

MASTER LEDspot ExpertColor LV

Photometric data

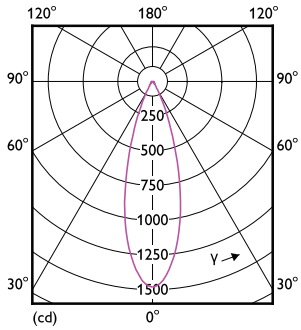

LEDspots GMGC 1 6,7W MR16 GU5,3 930 36D-LDD

Lifetime



LEDspots LED 40K



LEDspots LMP 40K

