



# InfraRed Industrial Heat Incandescent

## PAR38 IR 100W E27 240V CL 1CT/12

The Philips infrared incandescent reflector lamps are designed to work in the toughest environment such as farm, bathroom or kitchen and their nearest surrounding. They have a reinforced construction thanks to hard glass use. Their compact form and universal cap base allow them to be used with any suitable equipment. A very good method of generating warmth is by using heat lamps. The Philips infrared lamps provide direct, draught-free warmth to the animals, people, but also food. These benefits have made farmers, consumers and cooks around the world choose Philips infrared lamps, because they are the sturdiest, most efficient lamps available for these applications.

### Product data

| General Information      |                            |
|--------------------------|----------------------------|
| Cap base                 | E27 [ E27]                 |
| Burning Position         | UNIVERSAL [ Any/Universal] |
| Main application         | Infrared Industrial        |
| Nominal lifetime (nom.)  | 5000 h                     |
| Light Technical          |                            |
| Colour Designation       | C                          |
| Operating and Electrical |                            |
| Power (Rated) (Nom)      | 100 W                      |
| Voltage (Nom)            | 240 V                      |
| Controls and Dimming     |                            |
| Dimmable                 | Yes                        |

| Mechanical and Housing            |                                  |
|-----------------------------------|----------------------------------|
| Lamp Finish                       | Clear                            |
| Bulb material                     | Hard Glass                       |
| Product Data                      |                                  |
| Full product code                 | 871150012893515                  |
| Order product name                | PAR38 IR 100W E27 240V CL 1CT/12 |
| EAN/UPC – product                 | 8711500128935                    |
| Order code                        | 923801245506                     |
| SAP numerator – quantity per pack | 1                                |
| Numerator – packs per outer box   | 12                               |
| SAP material                      | 923801245506                     |
| SAP net weight (piece)            | 308.000 g                        |

## InfraRed Industrial Heat Incandescent

### Dimensional drawing

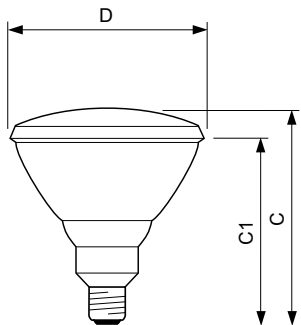

| Product                          | D      | C (max) | C1 (max) |
|----------------------------------|--------|---------|----------|
| PAR38 IR 100W E27 240V CL 1CT/12 | 121 mm | 136 mm  | 124 mm   |

PAR38 IR 100W E27 240V CL

